

roba

roba Baumann GmbH

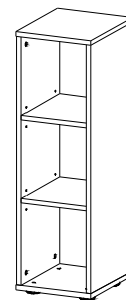
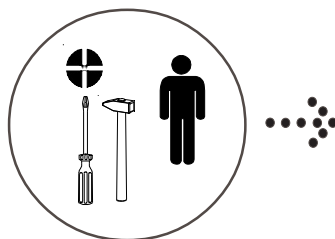

Feldstraße 14
96237 Ebersdorf
0 95 62. 92 21-20
info@roba-kids.com
www.roba-kids.com

**1341772 Seitenregal. Shelf****„Constantin“**

Aufbauanleitung . Assembly Instructions . Instruction d'assemblage . Instrucciones de montaje . Instruções de montagem . Istruzioni di montaggio . Opbouwhandleiding . Byggevejledning . Monteringsanvisning . Asennusohjeet . Monteringsinstruksjoner . Instrukcja montażu . Návod k sestavení . Szerelési útmutató . Skupština Upute . Instrucțiuni de asamblare . Uputstvo za sastavljanje . Montážny návod . Navodila za montažo . Montaj talimatı . Οδηγίες Συναρμολόγησης . Руководство по сборке

- DE** WICHTIG! - FÜR SPÄTERE VERWENDUNG AUFBEWAHREN - SORGFÄLTIG LESEN!
UK ATTENTION! - PLEASE STORE FOR FURTHER ENQUIRIES! READ CAREFULLY!
FR IMPORTANT! - CONSERVER POUR UNE UTILISATION ULTÉRIEURE - LIRE ATTENTIVEMENT!
ES ¡ATENCIÓN! - GUARDAR PARA UN USO POSTERIOR. - LÉASE DETENIDAMENTE!
PT IMPORTANTE! – GUARDAR PARA FUTURAS CONSULTAS – LER COM ATENÇÃO!
IT IMPORTANTE! CONSERVARE PER L'USO FUTURO - LEGGERE CON ATTENZIONE!
NL BELANGRIJK! - BEWAAR DE HANDLEIDING VOOR LATERE RAADPLEGING! ZORGVULDIG LEZEN!
DK VIGTIGT! BØR OPBEVARES TIL SENERE BRUG - SKAL LÆSES GRUNDIGT!
SE VIKTIGT! SPARAS FÖR FRAMTIDA BRUK - MÅSTE LÄSAS NOGA!
FI TÄRKEÄÄ! - SÄILYTÄ MYÖHEMPÄÄ KÄYTTÖÄ VARTEN – LUE TARKKAVAISESTI!
NO VIKTIG! – OPPBEVARES FOR SENERE BRUK – MÅ LESES NØYE!
PL WAŻNE! ZACHOWAĆ NA PRZYSZŁOŚĆ! STARANNIE PRZECZYTAĆ!
CZ DŮLEŽITÉ! - NÁVOD SI USCHÓVEJTE PRO POZDĚJŠÍ POUŽITÍ! - PEČLIVĚ SI JEJ PROČTĚTE!
HU FONTOS! – KÉSŐBBI FELHASZNÁLÁSRA ÓRIZZE MEG – GONDOSAN OLVASSA EL!
HR VAŽNO! - SAČUVATI ZA KASNIJU UPORABU – PAŽLJIVO PROČITATI!
RO IMPORTANT! - PĂSTRĂȚI PENTRU UTILIZARE ULTERIOARĂ - CITIȚI CU ATENȚIE!
RS VAŽNO! – ČUVATI ZA KASNIJU UPOTREBU – PAŽLJIVO SVE PROČITATI!
SK DÔLEŽITÉ! - NÁVOD UCHOVAJTE NA NESKORŠIE POUŽITIE – DÔKLADNE SI HO PREČÍTAJTE!
SI POMEMBNO! – SHRANITE ZA KASNEJŠO UPORABO – TEMELJITO PREBERITE!
TR ÖNEMLİ!-DAHA SONRA KULLANILMAK ÜZERE DE MUHAFZA EDİNİZ– DIKKATLE OKUYUNUZ!
GR ΣΗΜΑΝΤΙΚΟ! - ΝΑ ΦΥΛΑΣΣΕΤΑΙ ΓΙΑ ΑΡΓΟΤΕΡΗ ΧΡΗΣΗ - ΝΑ ΔΙΑΒΑΖΕΤΑΙ ΜΕ ΠΡΟΣΟΧΗ!
RU ВАЖНО: ВНИМАТЕЛЬНО ПРОЧИТАТЕ И СОХРАНИТЕ!



72003-11.16.





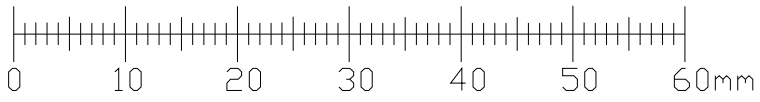

Service

@ info@roba-kids.com
www.roba-kids.com

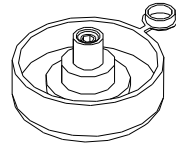
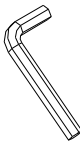

Bei Rückfragen zu diesem Artikel bitte die folgende Kenn-Nummer und Art.-Nr. angeben:
If you have any questions concerning this article use this identification number
and item number:

1341772- HU

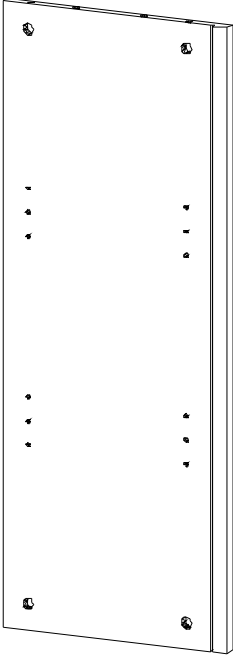
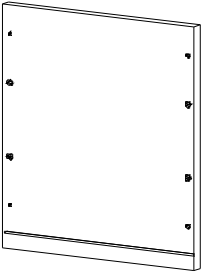
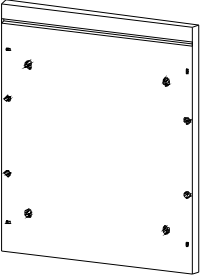
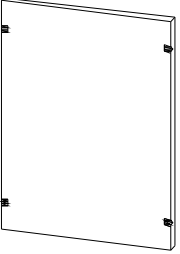
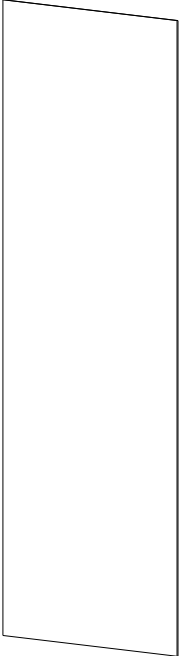

1	2	3	4	5	6	7	8	9	
8x	8x	8x	4x	1x	8x	4x	8x	4x	
		 ø15/12mm							

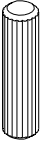
A	B	C	D
2x	1x	1x	1x
			
E			
1x			
			

1	3
	
8x	8x

1.

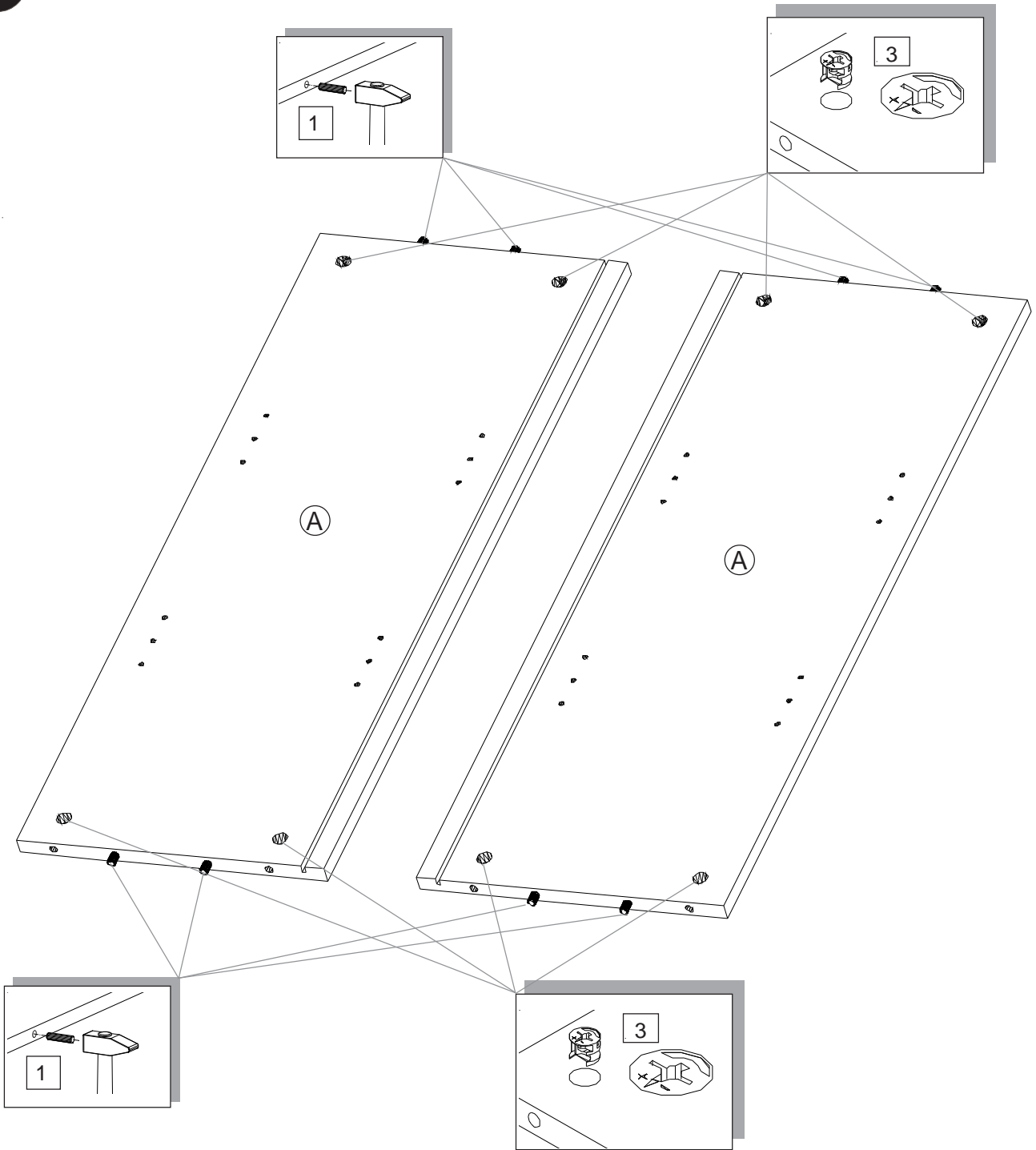

2	4	
		
8x	4x	

2.

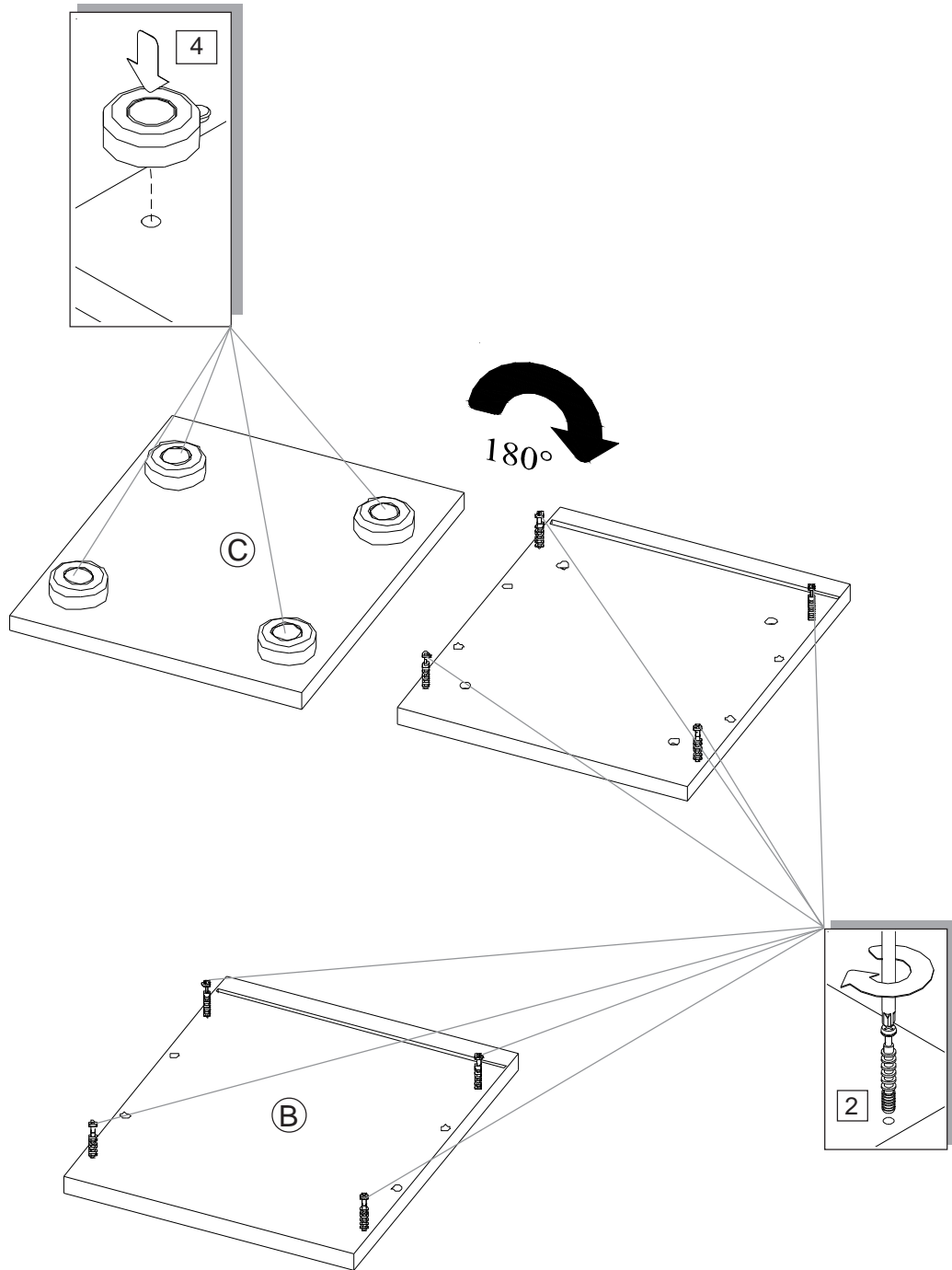

7	8	
		
4x	8x	

3.

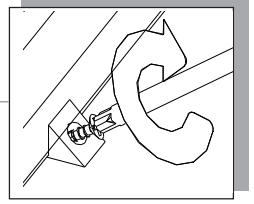
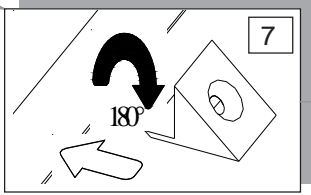
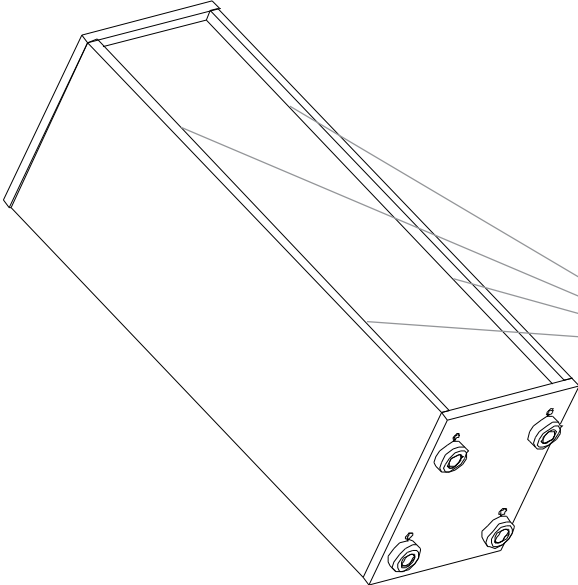
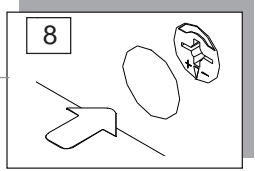
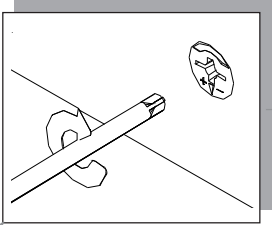
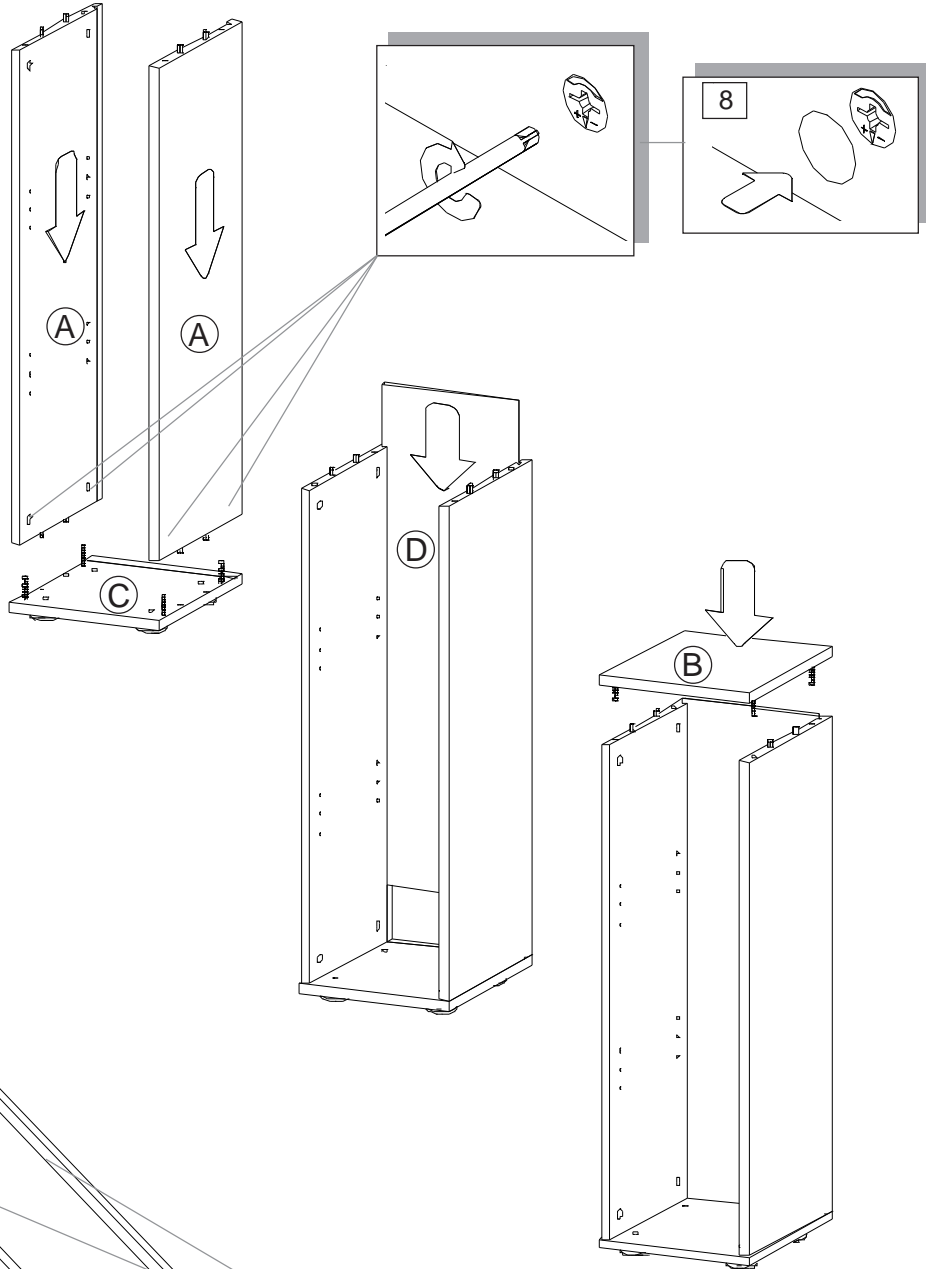

5	6	9	
			
1x	8x	4x	

4.

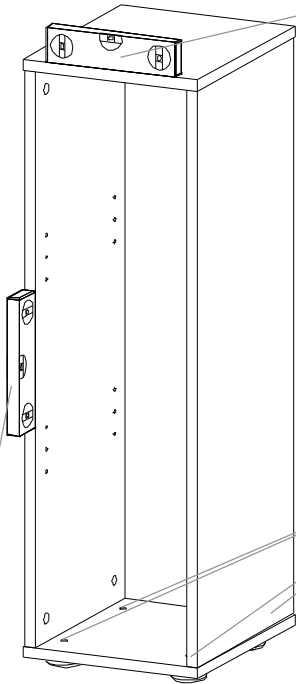
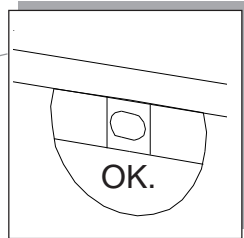

1.

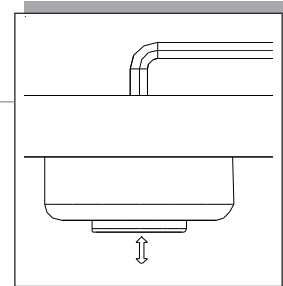
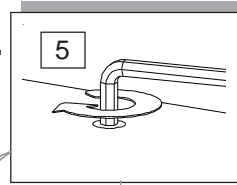

2.

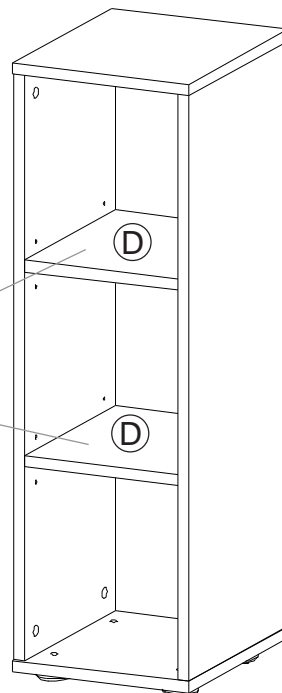
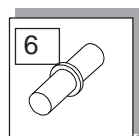
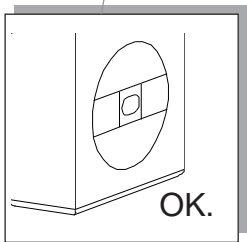
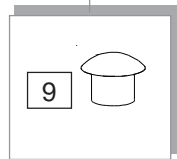

DE Sicherheitshinweise

- Verwenden Sie zum Reinigen der Oberflächen nur ein leicht feuchtes Tuch. Keinesfalls scheuernde oder ätzende Mittel bzw. harte Reinigungsbürsten etc. verwenden.

UK Notes on safety

- Clean the surfaces only with a slightly damp cloth. Never use abrasive or corrosive substances or hard cleaning brushes etc.

FR Consignes de sécurité

- N'utiliser qu'un chiffon légèrement humide pour nettoyer les surfaces. N'utiliser en aucun cas des produits récurants ou corrosifs ou des brosses dures etc.

ES Instrucciones de seguridad

- Use para limpiar las superficies únicamente un paño ligeramente humedecido. No use nunca medios abrasivos o agresivos ni cepillos de limpieza duros, etc.

PT Instruções de segurança

- Para limpar as superfícies, utilize somente um pano ligeiramente húmido. Nunca utilize produtos abrasivos ou corrosivos, nem escovas de limpeza de pêlos duros.

IT Informazioni di sicurezza

- Pulire le superfici con un panno leggermente inumidito. Non usare mai mezzi abrasivi o corrosivi oppure spazzole dure eccetera.

NL Veiligheidsinstructies

- Gebruik uitsluitend een licht vochtige doek om de oppervlakken te reinigen. In geen geval schurende of bijtende middelen c.q. harde reinigingsborstels enz. gebruiken.

DK Sikkerhedshenvisninger

- Anvend kun en let fugtet klud til rengøring af overfladerne. Anvend under ingen omstændigheder skurende eller ætsende rengøringsmidler eller hårde rengøringsbørster etc.

SE Säkerhetsinformation

- Använd endast en något fuktad duk för rengöring av ytorna. Använd aldrig skurande eller frätande medel resp. hårda rengöringsborstar.

FI Turvaohjeet

- Käytä pintojen puhdistukseen vain kevyesti kostutettua liinaa. Älä missään tapauksessa käytä hankaavia tai syövyttäviä aineita tai kovia puhdistusharjoja jne.

NO Sikkerhetsanvisninger

- Benytt for rengjøring av overflatene bare en lett fuktig klut. Bruk under ingen omstendighet skurende eller etsende midler hhv. harde rengjøringsbørster etc.

PL Wskazówki bezpieczeństwa

- Do czyszczenia powierzchni używać delikatnie zwilżonej ściereczki. Nie wolno stosować środków o działaniu szorującym lub zręczym ani też szczotek itp.

CZ Bezpečnostní pokyny

- K čištění povrchu používejte vždy pouze lehce navlhlý hadřík. V žádném případě nepoužívejte abrazivní či leptající prostředky nebo tvrdé čisticí kartáče apod.

HR Sigurnosne upute

- Za čišćenje površina koristite samo lagano navlaženu krpu. Nikako ne koristite sredstva koja grebu ili nagrizaju, odn. krute četke za čišćenje itd.

HU Biztonsági előírások

- A felületek tisztítására csak enyhén nedves ruhát használjon! Semmiképp ne használjon súroló vagy maró szereket, ill. kemény tisztítókeféket, stb.!

RO Indicații de securitate

- Utilizați pentru curățarea suprafețelor doar o cârpă ușor umezită. Sub nicio formă nu utilizați agenți abrazivi sau caustici, respectiv perii dure de curățare etc.

RS Sigurnosne upute

- Koristite za čišćenje površina samo lagano mokru krpu. Ni u kome slučaju koristite abraziona ili korozivna sredstva odnosno jake četke za čišćenje.

SK Bezpečnostné upozornenia

- Na čistenie povrchov používajte iba jemne navlhčenú utierku. V žiadnom prípade nepoužívajte práškové alebo žieravé čistiace prostriedky, príp. kefy na čistenie a p

SI Varnostna navodila

- Za čiščenje površin uporabljajte le rahlo navlaženo krpo. V nobenem primeru ne smete uporabljati abrazivnih ali jedkih sredstev oz. trdih ščetk za čiščenje ipd.

TR Güvenlik uyarıları

- Yüzeylerin temizliği için sadece hafifçe nemlendirilmiş bir bez kullanınız. Kesinlikle çizici veya aşındırıcı maddeler ya da sert temizlik fırçaları v.s. kullanmayınız.

GR Υποδείξεις ασφαλείας

- Για τον καθαρισμό της βερνικωμένης επιφάνειας χρησιμοποιείτε μόνο ένα ελαφρώς βρεγμένο πανί. Μη χρησιμοποιείτε σε καμία περίπτωση ουσίες τριψίματος ή καυστικές ουσίες, σκληρές βούρτσες καθαρισμού κ.ο.κ.

RU Информация по технике безопасности

- Для чистки используйте только мягкие моющие средства и средства по уходу. Протирайте матрас для пеленания влажным полотенцем.