

roba

roba Baumann GmbH

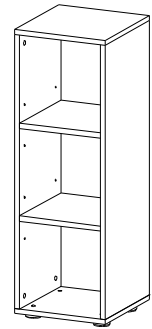

✉ Feldstraße 14
 96237 Ebersdorf
 ☎ 0 95 62. 92 21-20
 ✉ info@roba-kids.com
 @ www.roba-kids.com

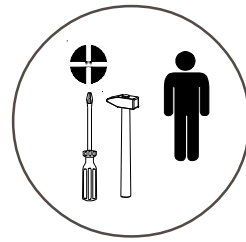

1341792 Seitenregal. Shelf

„Finn“

Aufbauanleitung . Assembly Instructions . Instruction d'assemblage . Instrucciones de montaje . Instruções de montagem . Istruzioni di montaggio . Opbouwhandleiding . Byggevejledning . Monteringsanvisning . Asennusohjeet . Montering Instruksjoner . Instrukcja montażu . Návod k sestavení . Szerelési útmutató . Skupština Upute . Instrucțiuni de asamblare . Uputstvo za sastavljanje . Montážny návod . Navodila za montažo . Montaj talimatı . Οδηγίες Συναρμολόγησης . Руководство по сборке

- DE** WICHTIG! - FÜR SPÄTERE VERWENDUNG AUFBEWAHREN - SORGFÄLTIG LESEN!
- UK** ATTENTION! - PLEASE STORE FOR FURTHER ENQUIRIES! READ CAREFULLY!
- FR** IMPORTANT! - CONSERVER POUR UNE UTILISATION ULTÉRIEURE - LIRE ATTENTIVEMENT!
- ES** ¡ATENCIÓN! - GUARDAR PARA UN USO POSTERIOR. - LÉASE DETENIDAMENTE!
- PT** IMPORTANTE! – GUARDAR PARA FUTURAS CONSULTAS – LER COM ATENÇÃO!
- IT** IMPORTANTE! CONSERVARE PER L'USO FUTURO - LEGGERE CON ATTENZIONE!
- NL** BELANGRIJK! - BEWAAR DE HANDLEIDING VOOR LATERE RAADPLEGING! ZORGVULDIG LEZEN!
- DK** VIGTIGT! BØR OPBEVARES TIL SENERE BRUG - SKAL LÆSES GRUNDIGT!
- SE** VIKTIGT! SPARAS FÖR FRAMTIDA BRUK - MÅSTE LÄSAS NOGA!
- FI** TÄRKEÄÄ! - SÄILYÄ MYÖHEMPÄÄ KÄYTTÖÄ VARTEN – LUE TARKKAVAISESTI!
- NO** VIKTIG! – OPPBEVARES FOR SENERE BRUK – MÅ LESES NØYE!
- PL** WAŻNE! ZACHOWAĆ NA PRZYSZŁOŚĆ! STARANNIE PRZECZYTAĆ!
- CZ** DŮLEŽITÉ! - NÁVOD SI USCHÓVEJTE PRO POZDĚJŠÍ POUŽITÍ! - PEČLIVĚ SI JEJ PROČTĚTE!
- HU** FONTOS! – KÉSŐBBI FELHASZNÁLÁSRA ŐRIZZE MEG – GONDOSAN OLVASSA EL!
- HR** VAŽNO! - SAČUVATI ZA KASNIJU UPORABU – PAŽLJIVO PROČITATI!
- RO** IMPORTANT! - PĂSTRĂȚI PENTRU UTILIZARE ULTERIOARĂ - CITIȚI CU ATENȚIE!
- RS** VAŽNO! – ČUVATI ZA KASNIJU UPOTREBU – PAŽLJIVO SVE PROČITATI!
- SK** DÔLEŽITÉ! - NÁVOD UCHOVAJTE NA NEŠKORŠIE POUŽITIE – DÔKLADNE SI HO PREČÍTAJTE!
- SI** POMEMBNO! – SHRANITE ZA KASNEJŠO UPORABO – TEMELJITO PREBERITE!
- TR** ÖNEMLİ!-DAHA SONRA KULLANILMAK ÜZERE DE MUHAFAZA EDİNİZ– DIKKATLE OKUYUNUZ!
- GR** ΣΗΜΑΝΤΙΚΟ! - ΝΑ ΦΥΛΑΣΣΕΤΑΙ ΓΙΑ ΑΡΓΟΤΕΡΗ ΧΡΗΣΗ - ΝΑ ΔΙΑΒΑΖΕΤΑΙ ΜΕ ΠΡΟΣΟΧΗ!
- RU** ВАЖНО: ВНИМАТЕЛЬНО ПРОЧИТАТЕ И СОХРАНИТЕ!



72003-03.19.

Service

@ info@roba-kids.com
 www.roba-kids.com







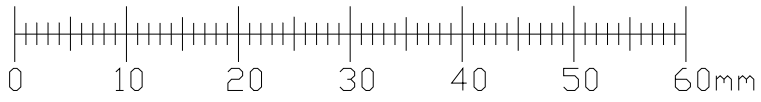

Bei Rückfragen zu diesem Artikel bitte die folgende Kenn-Nummer und Art.-Nr. angeben.
 If you have any questions concerning this article use this identification number
 and item number:

1341792-

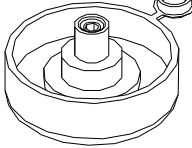
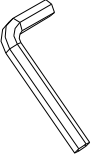

HU

1341792-1/7



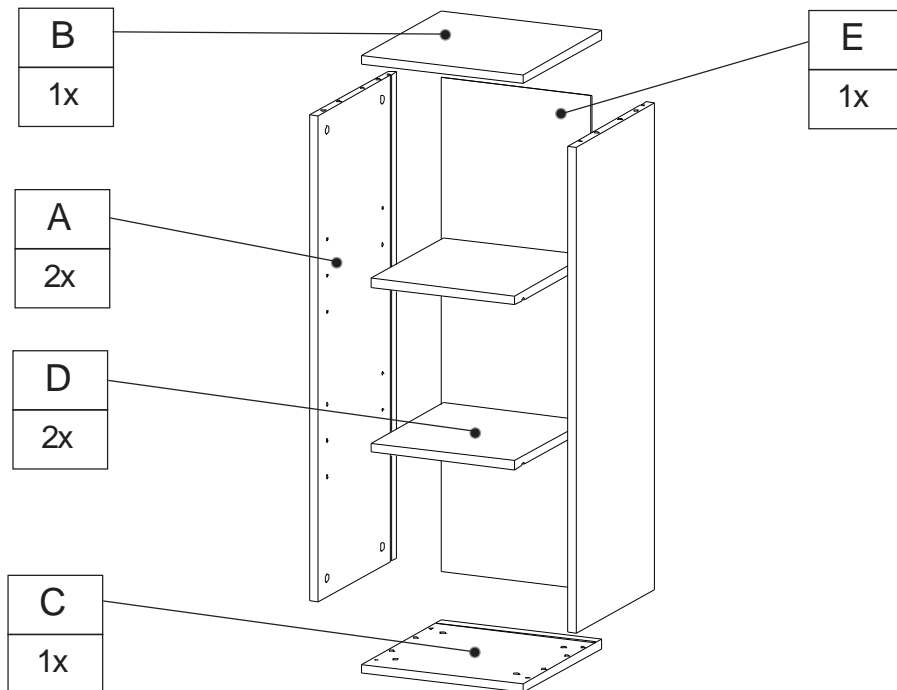

O02	E02	E06	L11	W05	T01	D09	W07	L02
8x	8x	8x	8x	4x	8x	4x	1x	4x
								
ø8/30mm	ø15/16mm						4mm	ø10mm



O02	E02	
		
8x	8x	

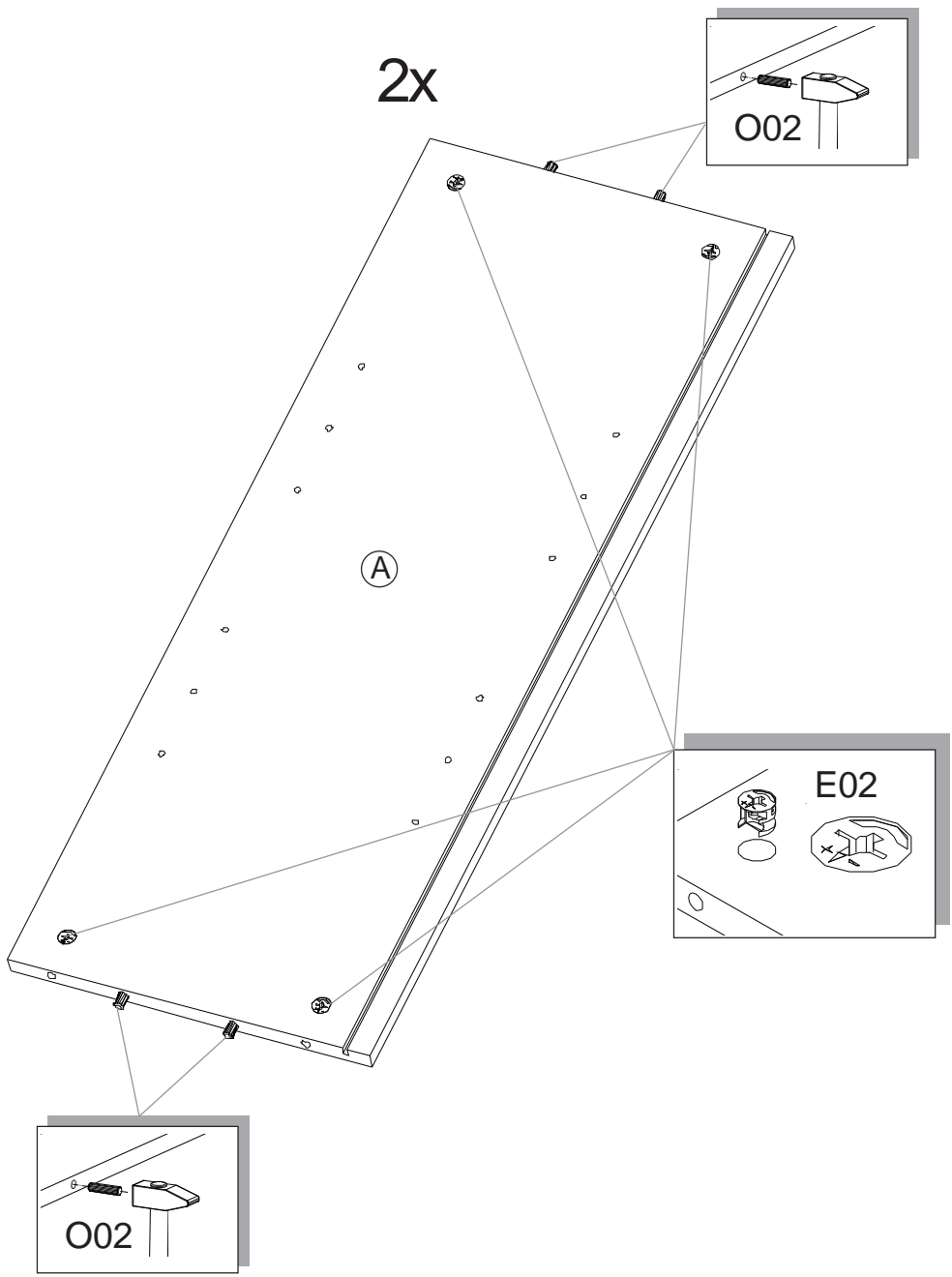

1.

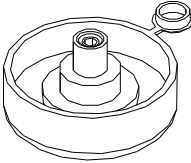

E06	D09	
		
8x	4x	

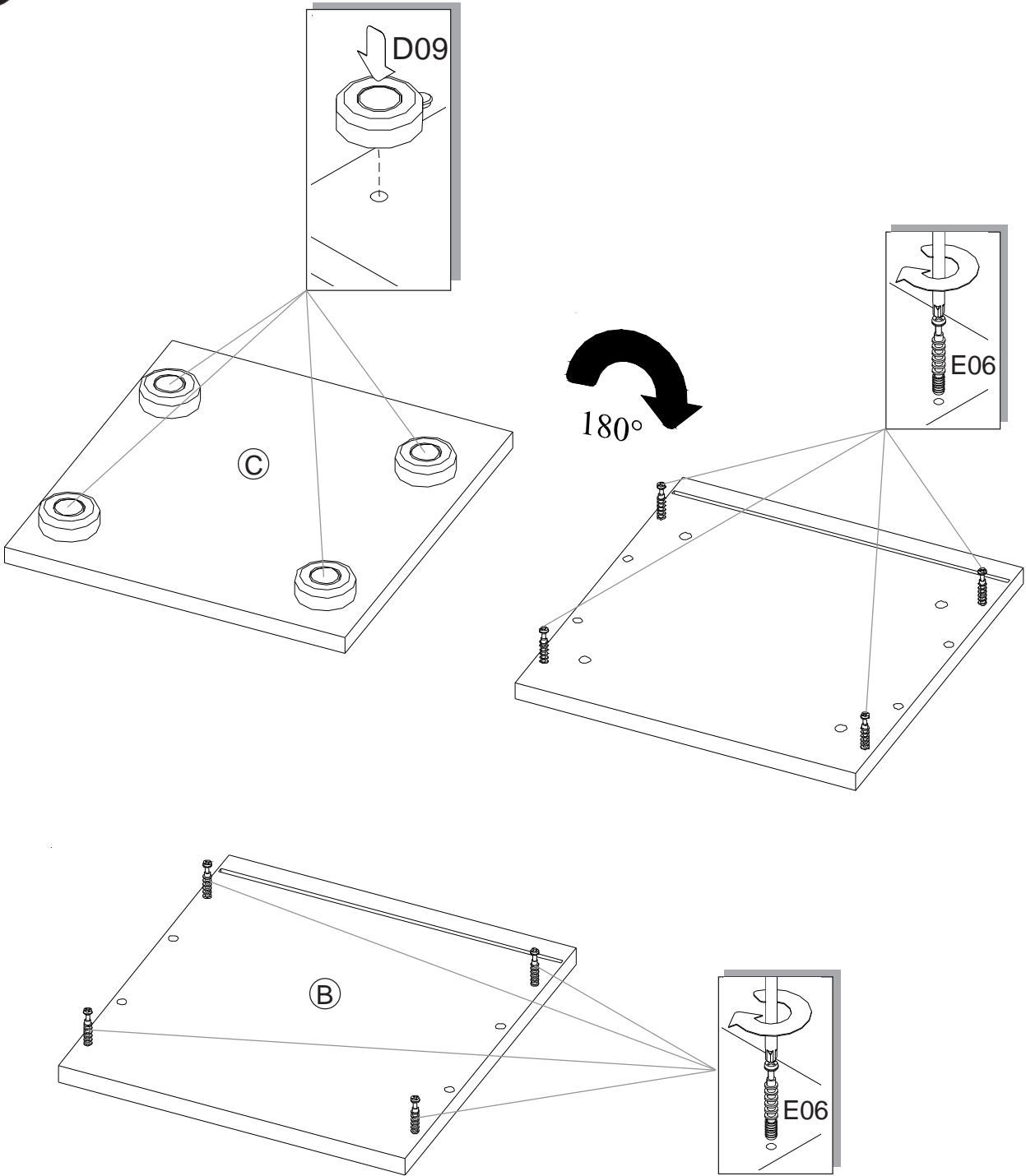

2.

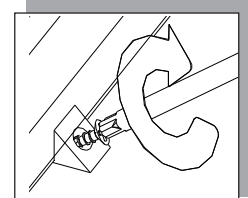
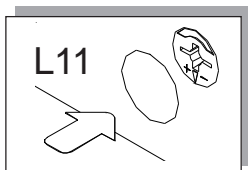
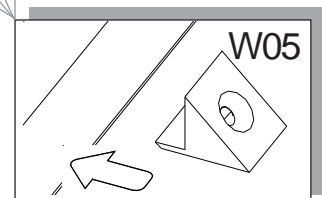
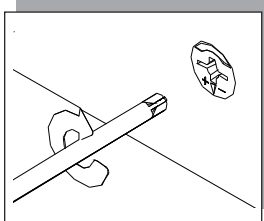
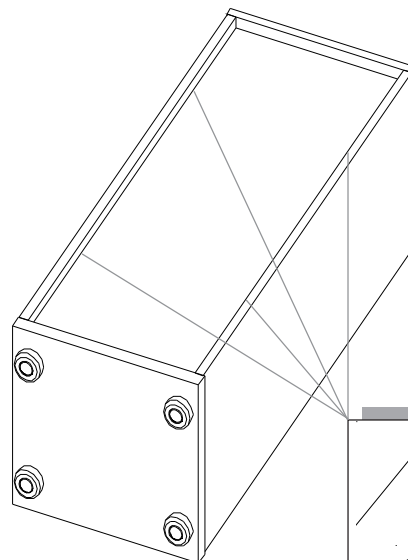
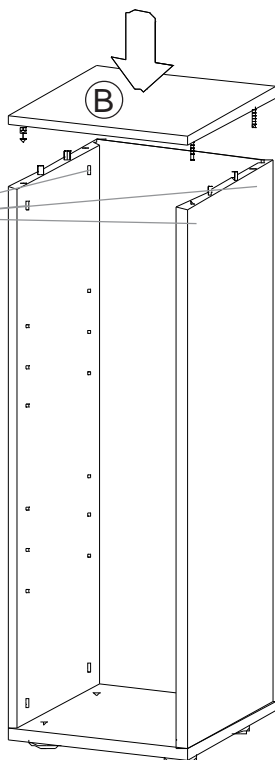
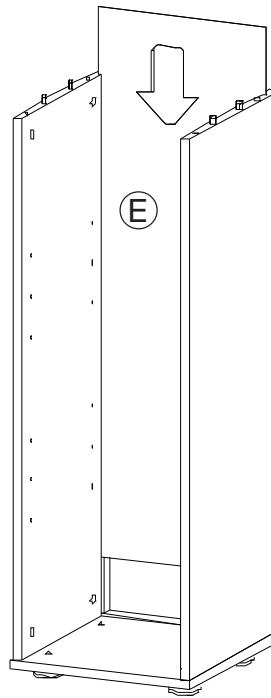
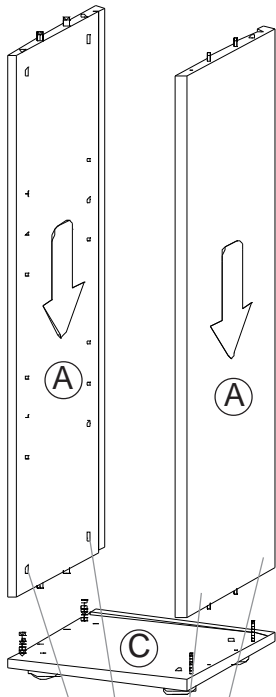

W05	L11	
		
4x	8x	

3.



T01	W07	L02
		
8x	1x	4x

4.

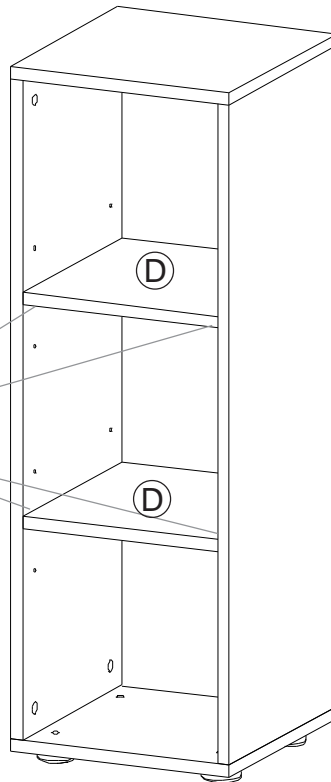
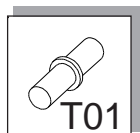
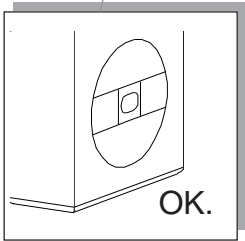
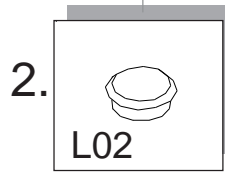
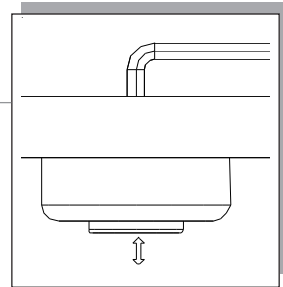
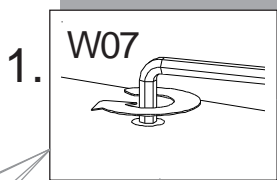
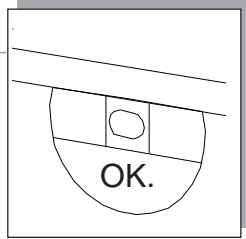
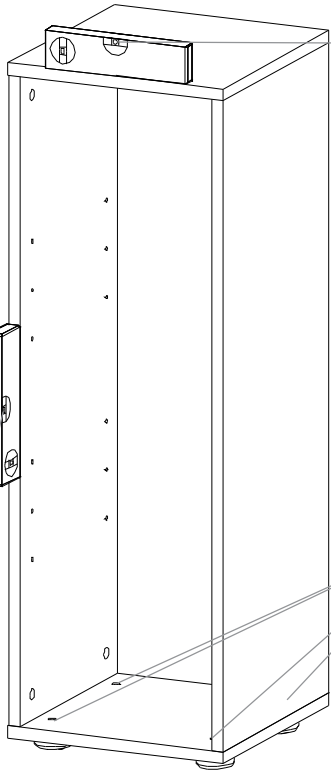

DE

Sicherheitshinweise

- Verwenden Sie zum Reinigen der Oberflächen nur ein leicht feuchtes Tuch. Keinesfalls scheuernde oder ätzende Mittel bzw. harte Reinigungsbürsten etc. verwenden.

UK

Notes on safety

- Clean the surfaces only with a slightly damp cloth. Never use abrasive or corrosive substances or hard cleaning brushes etc.

FR

Consignes de sécurité

- N'utiliser qu'un chiffon légèrement humide pour nettoyer les surfaces. N'utiliser en aucun cas des produits récurants ou corrosifs ou des brosses dures etc.

ES

Instrucciones de seguridad

- Use para limpiar las superficies únicamente un paño ligeramente humedecido. No use nunca medios abrasivos o agresivos ni cepillos de limpieza duros, etc.

PT

Instruções de segurança

- Para limpar as superfícies, utilize somente um pano ligeiramente húmido. Nunca utilize produtos abrasivos ou corrosivos, nem escovas de limpeza de pêlos duros.

IT

Informazioni di sicurezza

- Pulire le superfici con un panno leggermente inumidito. Non usare mai mezzi abrasivi o corrosivi oppure spazzole dure eccetera.

NL

Veiligheidsinstructies

- Gebruik uitsluitend een licht vochtige doek om de oppervlakken te reinigen. In geen geval schurende of bijtende middelen c.q. harde reinigingsborstels enz. gebruiken.

DK

Sikkerhedshenvisninger

- Anvend kun en let fugtet klud til rengøring af overfladerne. Anvend under ingen omstændigheder skurende eller ætsende rengøringsmidler eller hårde rengøringsbørster etc.

SE

Säkerhetsinformation

- Använd endast en något fuktad duk för rengöring av ytorna. Använd aldrig skurande eller frätande medel resp. hårda rengöringsborstar.

FI

Turvaohjeet

- Käytä pintojen puhdistukseen vain kevyesti kostutettua liinaa. Älä missään tapauksessa käytä hankaavia tai syövyttäviä aineita tai kovia puhdistusharjoja jne.

NO

Sikkerhetsanvisninger

- Benytt for rengjøring av overflatene bare en lett fuktig klut. Bruk under ingen omstendighet skurende eller etsende midler hhv. harde rengjøringsbørster etc.

PL

Wskazówki bezpieczeństwa

- Do czyszczenia powierzchni używać delikatnie zwilżonej ściereczki. Nie wolno stosować środków o działaniu szorującym lub żrącym ani też szczotek itp.

CZ

Bezpečnostní pokyny

- K čištění povrchu používejte vždy pouze lehce navlhčený hadřík. V žádném případě nepoužívejte abrazivní či leptající prostředky nebo tvrdé čisticí kartáče apod.

HR

Sigurnosne upute

- Za čišćenje površina koristite samo lagano navlaženu krpu. Nikako ne koristite sredstva koja grebu ili nagrizaju, odn. krute četke za čišćenje itd.

HU

Biztonsági előírások

- A felületek tisztítására csak enyhén nedves ruhát használjon! Semmiképp ne használjon súroló vagy maró szereket, ill. kemény tisztítókeféket, stb.!

RO

Indicații de securitate

- Utilizați pentru curățarea suprafețelor doar o cârpă ușor umezită. Sub nicio formă nu utilizați agenți abrazivi sau caustici, respectiv perii dure de curățare etc.

RS

Sigurnosne upute

- Koristite za čišćenje površina samo lagano mokru krpu. Ni u kome slučaju koristite abraziona ili korozivna sredstva odnosno jake četke za čišćenje.

SK

Bezpečnostné upozornenia

- Na čistenie povrchov používajte iba jemne navlhčenú utierku. V žiadnom prípade nepoužívajte práškové alebo žieravé čistiace prostriedky, príp. kefy na čistenie a p

SI

Varnostna navodila

- Za čiščenje površin uporabljajte le rahlo navlaženo krpو. V nobenem primeru ne smete uporabljati abrazivnih ali jedkih sredstev oz. trdih ščetk za čiščenje ipd.

TR

Güvenlik uyarıları

- Yüzeylerin temizliği için sadece hafifçe namlendirilmiş bir bez kullanınız. Kesinlikle çizici veya aşındırıcı maddeler ya da sert temizlik fırçaları v.s. kullanmayınız.

GR

Υποδείξεις ασφαλείας

- Για τον καθαρισμό της βερνικωμένης επιφάνειας χρησιμοποιείτε μόνο ένα ελαφρώς βρεγμένο πανί. Μη χρησιμοποιείτε σε καμία περίπτωση ουσίες τριψίματος ή καυστικές ουσίες, σκληρές βούρτσες καθαρισμού κ.ο.κ.

RU

Информация по технике безопасности

- Для чистки используйте только мягкие моющие средства и средства по уходу. Протирайте матрас для пеленания влажным полотенцем.